

# CURVE 90

SUSPENDED FIRE



 **NAKED FLAME**

# CURVE 90

Installation manual  
available on request.

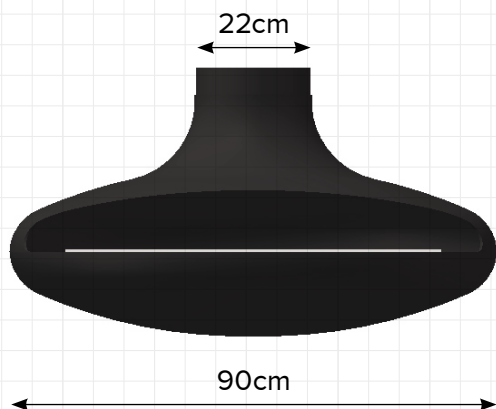

45cm

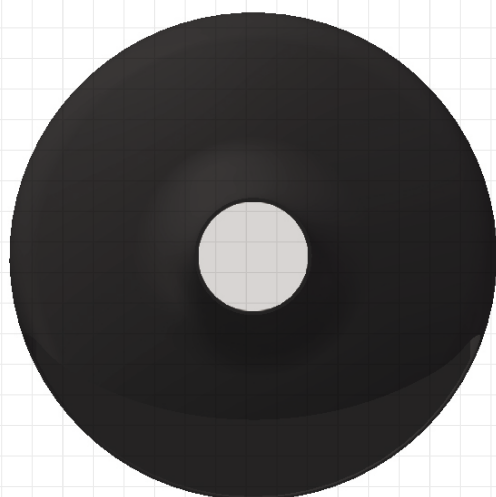
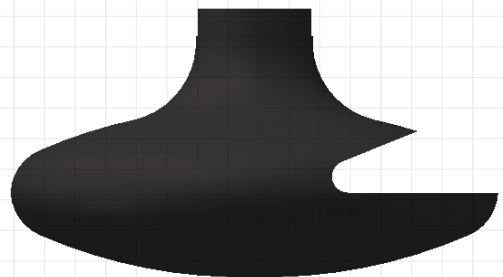

90cm

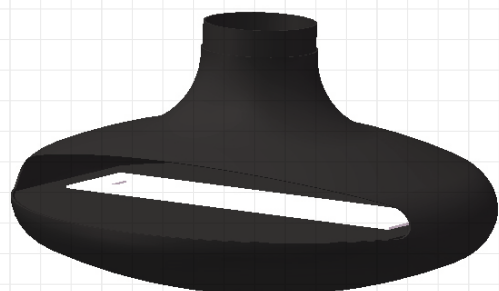

## **FIRE INSERT OPTIONS:**

- **BIOFUEL** - Eco-friendly, 100% heat-efficient and clean burning, which means no smoke so you don't need a chimney or a consent.
- **GAS** (Natural or LPG) - We offer a gas insert option (through a third party).
- **ELECTRIC** - Just for looks, but what stunningly beautiful looks.
- **WOOD** - Suitable for rural areas, check with your local council for emission requirements.

360 degree rotation system.

Flue can be customised to various lengths and ceiling slope.

## **MATERIALS**

- Material: Cold rolled steel
- Thickness: 4mm
- Colour: Black

## **GUARANTEE**

Full money back 5 year guarantee on any faulty product.

## **VISIT OUR STORE**

72 Barrys Point Road  
Takapuna  
Auckland

## **CONTACT US**

0800 468 836  
sales@nakedflame.nz  
nakedflame.nz

**NAKED FLAME**  
DESIGNER BIOFUEL FIREPLACES

Addressing the demand for incorporating stretched flames into custom-designed settings, the linear features of the XL burners perfectly combine their sleek parallel lines with the clean lines of today's contemporary living. An elegant, bright, elongated flame helps 'make' an indoor or outdoor room and creates a distinctive drawcard.

Perfectly and easily integrated into media units, cabinetry, walls, pillars or stone benches, XL burners come in a range of sizes depending on the style you want to achieve. The many, diverse installations around the world are testament to the versatility of these amazing burners.

INDICATIVE MODEL SHOWN BELOW

#### Included Accessories



#### Flame Regulation

Purpose-designed baffle inserts allow you to regulate and further stabilise the flame at the same time as increasing fuel efficiency of the burner.

#### Flip Lid Shut Off System

The series' 'flip lid' shut-off system fits perfectly across the ignition zone to extinguish the flame and, when it is open, denies access to the separated filling point as a deterrent to filling the burner while it is in operation.

A reliable and safe extinguishing system courtesy of a special shut-off mechanism and precision measurements.

#### Colour

Available in Stainless Steel.

#### Dedicated Filling Point

A patented filling point is separated from the ignition zone and engineered so that the jerry can spout is fully supported prior to releasing the fuel supply. This eliminates the usual splash and spills that would otherwise occur when fuel is decanted into the burner while simultaneously reinforcing the maximum fill line within the burner.

#### Shut Off Mechanism

XL burners operate under all conditions, at all temperatures, every time – reliable, consistent and reassuring.

#### Deep Drawn Fabrication

A deep-draw fabrication process eliminates the potential for dangerous leaks.

#### VISIT OUR STORE

72 Barrys Point Road  
Takapuna  
Auckland

#### CONTACT US

0800 468 836  
sales@nakedflame.nz  
nakedflame.nz

# XL700

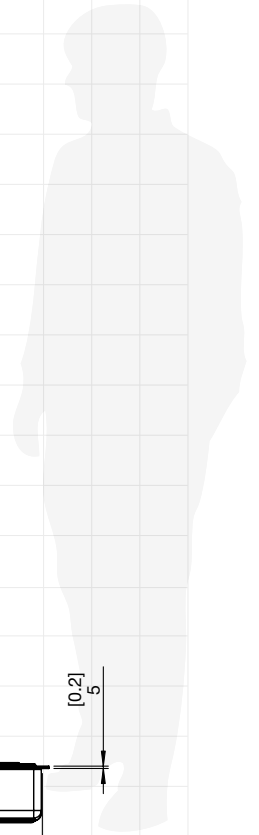

<b>Application</b>	Indoor & Outdoor
<b>Materials</b>	Grade 304 Stainless Steel
<b>Weight</b>	9.2kg [20.2lbs]
<b>Colour &amp; SKU</b>	Stainless Steel ESF.2.B.XL7
<b>Fuel Type</b>	e-NRG Bioethanol

#### BURNER VENTILATION & EFFICIENCY\*

<b>Fuel Capacity</b>	7 Litres [1.8 Gallons]
<b>Heats on Average</b> (when used indoors)	Over 50 square metres [538 square feet]
<b>Fuel Consumption</b>	0.7 L/h [0.18 Gal/h]
<b>Thermal Output Net (MAX)</b>	14.5 MJ/h - 13,650 BTU/h - 4 kW
<b>Burn Time</b>	9 - 12 hours (approx)
<b>Minimum Room Size</b>	90 cubic metres [3178 cubic feet] per burner.
<b>Optional Accessories</b>	Top Tray, Twin Feet Fixings, Fire Screens, Decorative Media

Read the manual carefully before operating the burner. Physical model dimensions should be verified against cut out dimensions BEFORE installation begins to confirm tolerances align.

\* The efficiency data outlined above is indicative only and may vary depending on the model purchased, weather conditions, installation and bioethanol used.



FRONT VIEW

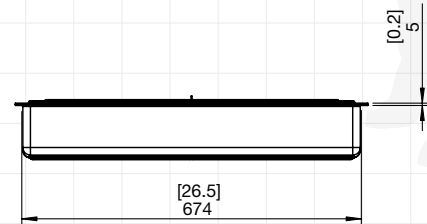

TOP VIEW

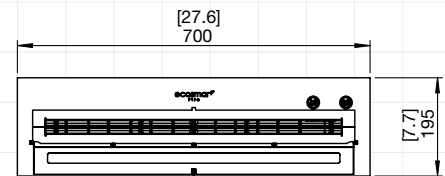

SIDE VIEW

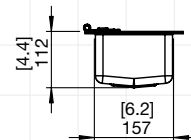

## VISIT OUR STORE

72 Barrys Point Road  
Takapuna  
Auckland

## CONTACT US

0800 468 836  
sales@nakedflame.nz  
nakedflame.nz

**NAKED FLAME**  
DESIGNER BIOFUEL FIREPLACES