

FLEX SINGLE SIDED FIREPLACES

FIREPLACE INSERTS



Clean Burning

Fueled by clean burning e-NRG bioethanol

Toughened Safety Screen

Your Flex Fireplace features toughened glass to stabilise the flame in windy conditions and provide an additional layer of safety and comfort. The Integrated windscreen sits flush behind the frame.

Single Room Application

Single Sided fireplaces feature one open side - view the flame from the front.

UL Listed

Every model in the Flex Series is manufacturer approved for use with EcoSmart's UL Listed burners.



Decorative Side Box

When a decorative box is added, the panel between the standard fire and the decorative box is glass.

Luxurious Finish

Available in a timeless black finish, Flex Fireplaces come with stainless steel burners and black glass charcoal.

Built to Last a Lifetime

Zinc sealed steel construction powder coated with super hi-temp black paint prevents rusting so all fireplaces can be used both indoors or outdoors.

Decorative Steel Log Sets

EcoSmart Fire offers non-combustible logs as an optional, eye-catching accessory for models with the decorative side box. Made from stainless steel with a patina finish, they are available in two different finishes: Brass and Copper.

True Zero Clearance

Self-contained, zero clearance construction allows your Flex fireplace to be framed into wood or metal studs, providing installation freedom and flexibility for builders, architects, interior designers, landscapers and homeowners.



Decorative Steel Logs

Disclaimer. All product specifications and data are subject to change without notice and believed to be correct at the time of publication. The Fire Company Pty Ltd (TFC), its affiliates, agents, and employees, and all persons acting on its or their behalf (collectively, "The Fire Company"), disclaim any and all liability for any errors, inaccuracies or incompleteness contained herein or in any other disclosure relating to any product. TFC disclaims any and all liability arising out of the use or application of any product described herein or of any information provided herein to the maximum extent permitted by law. The product specifications do not expand or otherwise modify TFC's terms and conditions of purchase, including but not limited to the warranty expressed therein, which apply to these products. No license, express or implied, by estoppel or otherwise, to any intellectual property rights is granted by this document or by any conduct of TFC. Customers using or selling TFC products not expressly indicated for use in such applications do so entirely at their own risk and agree to fully indemnify TFC for any damages arising or resulting from such use or sale. Please contact authorised personnel from TFC to obtain written terms and conditions regarding products designed for such applications. Images are indicative only.

SINGLE SIDED FIREPLACES

FLEX18
Minimum Wall Length 635mm [25in]



18SS

FLEX60*
Minimum Wall Length 1,730mm [68in]



60SS.BXL

FLEX86
Minimum Wall Length 2,395mm [94in]



86SS

FLEX32
Minimum Wall Length 1,015 mm [40in]



32SS



60SS.BXR

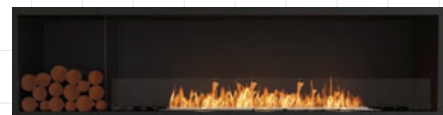

86SS.BXL

FLEX68
Minimum Wall Length 1,935mm [76in]

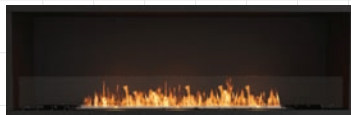

68SS



86SS.BXR

FLEX42*
Minimum Wall Length 1,270mm [50in]



42SS

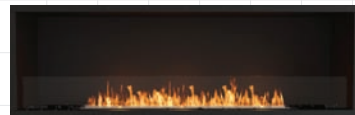

68SS.BXL

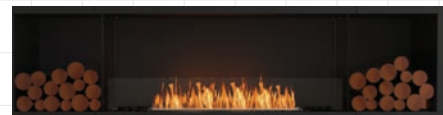

86SS.BX2

FLEX50
Minimum Wall Length 1,475mm [58in]



50SS



68SS.BXR

FLEX104
Minimum Wall Length 2,855mm [112in]

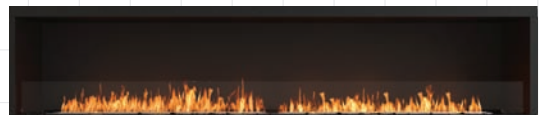

104SS



50SS.BXL



68SS.BX2

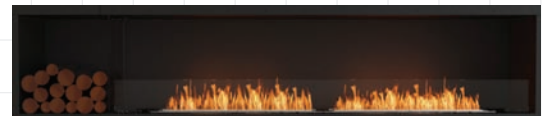

104SS.BXL



50SS.BXR

FLEX78*
Minimum Wall Length 2,190mm [86in]



78SS



104SS.BXR



104SS.BX2

*Not available in USA & Canada.

Disclaimer. All product specifications and data are subject to change without notice and believed to be correct at the time of publication. The Fire Company Pty Ltd (TFC), its affiliates, agents, and employees, and all persons acting on its or their behalf (collectively, "The Fire Company"), disclaim any and all liability for any errors, inaccuracies or incompleteness contained herein or in any other disclosure relating to any product. TFC disclaims any and all liability arising out of the use or application of any product described herein or of any information provided herein to the maximum extent permitted by law. The product specifications do not expand or otherwise modify TFC's terms and conditions of purchase, including but not limited to the warranty expressed therein, which apply to these products. No license, express or implied, by estoppel or otherwise, to any intellectual property rights is granted by this document or by any conduct of TFC. Customers using or selling TFC products not expressly indicated for use in such applications do so entirely at their own risk and agree to fully indemnify TFC for any damages arising or resulting from such use or sale. Please contact authorised personnel from TFC to obtain written terms and conditions regarding products designed for such applications. Images are indicative only.

SINGLE SIDED FIREPLACES

FLEX122

Minimum Wall Length 3,315mm [131in]



122SS



122SS.BX2



122SS.BXL

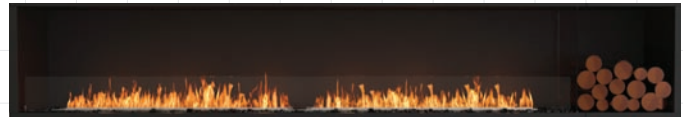

122SS.BXR

FLEX140

Minimum Wall Length 3,775mm [149in]



140SS.BXL



140SS.BXR



140SS.BX2

FLEX158

Minimum Wall Length 4,235mm [167in]

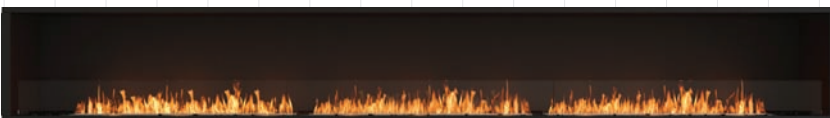

158SS

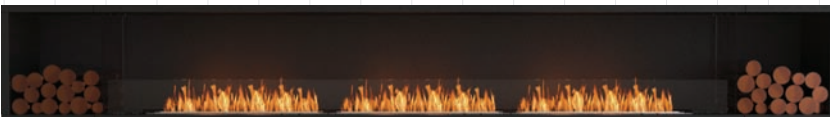

158SS.BX2

SINGLE SIDED FIREPLACES

| | |
|--------------------|---|
| Application | Indoor & Outdoor |
| Materials | Mild Steel (Zinc Sealed), Toughened Glass, Stainless Steel & Glass Charcoal as Decorative Media |
| Colours | Black Firebox, Stainless Steel Burner/s |
| Fuel Type | e-NRG Bioethanol |

FLEX18

ESF.1.FX.18SS

| | |
|--|--|
| Weight | 25.7kg [56.5lbs] (Incl. burner/s, glass charcoal, glass) |
| Burner* | AB3 x 1 |
| Volume Capacity | 2.5 Litres [0.7 Gallons] |
| Heats on Average (when used indoors) | Over 20 square metres [215 square feet] |
| Burn Time | 8 - 11 hours (approx) |
| Minimum Room Size | 40 cubic metres [1413 cubic feet] per fireplace. |

FLEX32

ESF.1.FX.32SS

| | |
|--|---|
| Weight | 45.7kg [100.5lbs] (Incl. burner/s, glass charcoal, glass) |
| Burner* | XL500 x 1 |
| Volume Capacity | 5 Litres [1.3 Gallons] |
| Heats on Average (when used indoors) | Over 40 square metres [430.6 square feet] |
| Burn Time | 10 - 13 hours (approx) |
| Minimum Room Size | 80 cubic metres [2825 cubic feet] per fireplace. |

FLEX42

ESF.1.FX.42SS (Not available in USA & Canada)

| | |
|--|---|
| Weight | 60kg [131.9lbs] (Incl. burner/s, glass charcoal, glass) |
| Burner* | XL700 x 1 |
| Volume Capacity | 7 Litres [1.8 Gallons] |
| Heats on Average (when used indoors) | Over 50 square metres [538 square feet] |
| Burn Time | 9 - 12 hours (approx) |
| Minimum Room Size | 90 cubic metres [3178 cubic feet] per fireplace. |

Physical model dimensions should be verified against cut out dimensions BEFORE installation begins to confirm tolerances align.

* The efficiency data outlined above is indicative only and may vary depending on the model purchased, weather conditions, installation and bioethanol used.

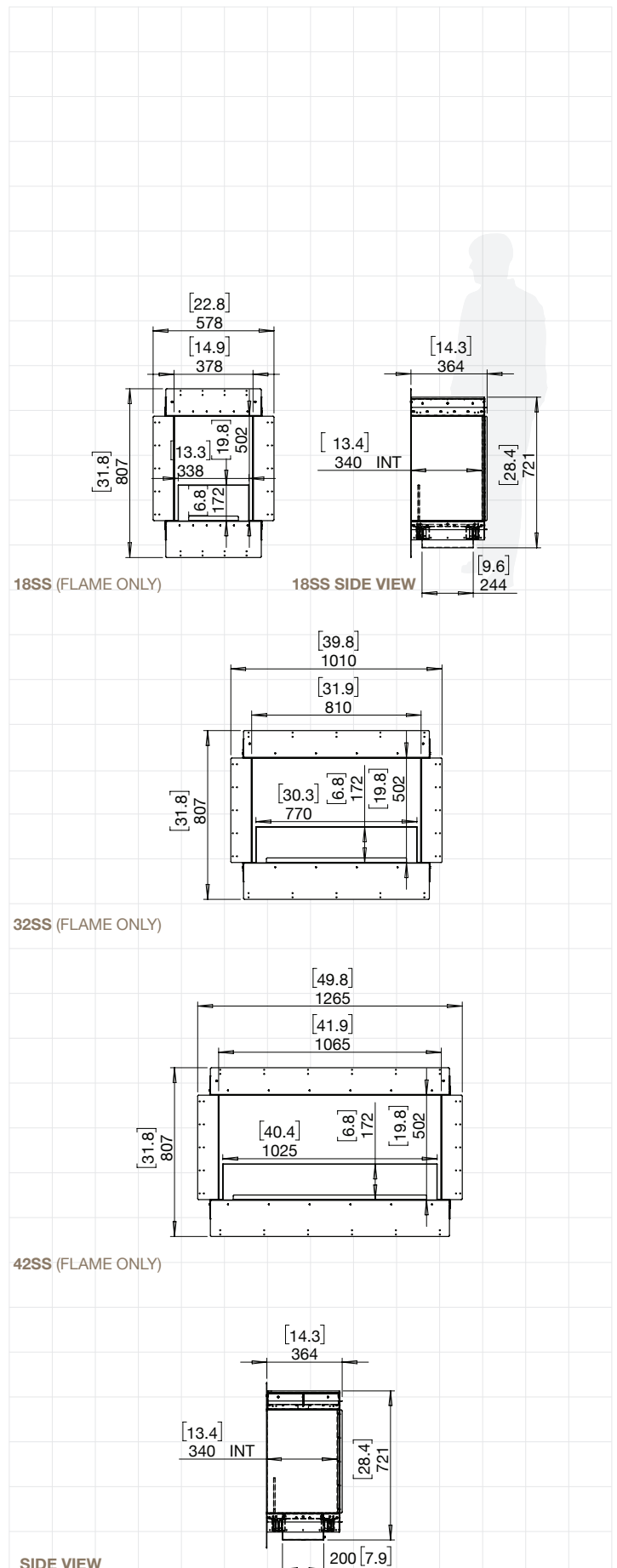

FOR MORE INFORMATION PLEASE REFERENCE THE CLEARANCE & INSTALLATION MANUAL

Disclaimer: All product specifications and data are subject to change without notice and believed to be correct at the time of publication. The Fire Company Pty Ltd (TFC), its affiliates, agents, and employees, and all persons acting on its or their behalf (collectively, "The Fire Company"), disclaim any and all liability for any errors, inaccuracies or incompleteness contained herein or in any other disclosure relating to any product. TFC disclaims any and all liability arising out of the use or application of any product described herein or of any information provided herein to the maximum extent permitted by law. The product specifications do not expand or otherwise modify TFC's terms and conditions of purchase, including but not limited to the warranty expressed therein, which apply to these products. No license, express or implied, by estoppel or otherwise, to any intellectual property rights is granted by this document or by any conduct of TFC. Customers using or selling TFC products not expressly indicated for use in such applications do so entirely at their own risk and agree to fully indemnify TFC for any damages arising or resulting from such use or sale. Please contact authorised personnel from TFC to obtain written terms and conditions regarding products designed for such applications. Images are indicative only.

SINGLE SIDED FIREPLACES

| | |
|--------------------|---|
| Application | Indoor & Outdoor |
| Materials | Mild Steel (Zinc Sealed), Toughened Glass, Stainless Steel & Glass Charcoal as Decorative Media |
| Colours | Black Firebox, Stainless Steel Burner/s |
| Fuel Type | e-NRG Bioethanol |

FLEX50

ESF.1.FX.50SS

| | |
|---|---|
| Weight | 71.4kg [157.1lbs] (Incl. burner/s, glass charcoal, glass) |
| Burner* | XL900 x 1 |
| Volume Capacity | 9 Litres [2.4 Gallons] |
| Heats on Average (when used indoors) | Over 60 square metres [645 square feet] |
| Burn Time | 8 - 13 hours (approx) |
| Minimum Room Size | 110 cubic metres [3884 cubic feet] per fireplace. |

ESF.1.FX.50SS.BXL ESF.1.FX.50SS.BXR

| | |
|---|---|
| Weight | 69.9kg [153.8lbs] (Incl. burner/s, glass charcoal, glass) |
| Burner* | XL500 x 1 |
| Volume Capacity | 5 Litres [1.3 Gallons] |
| Heats on Average (when used indoors) | Over 40 square metres [430.6 square feet] |
| Burn Time | 10 - 13 hours (approx) |
| Minimum Room Size | 80 cubic metres [2825 cubic feet] per fireplace. |

Physical model dimensions should be verified against cut out dimensions BEFORE installation begins to confirm tolerances align.

* The efficiency data outlined above is indicative only and may vary depending on the model purchased, weather conditions, installation and bioethanol used.

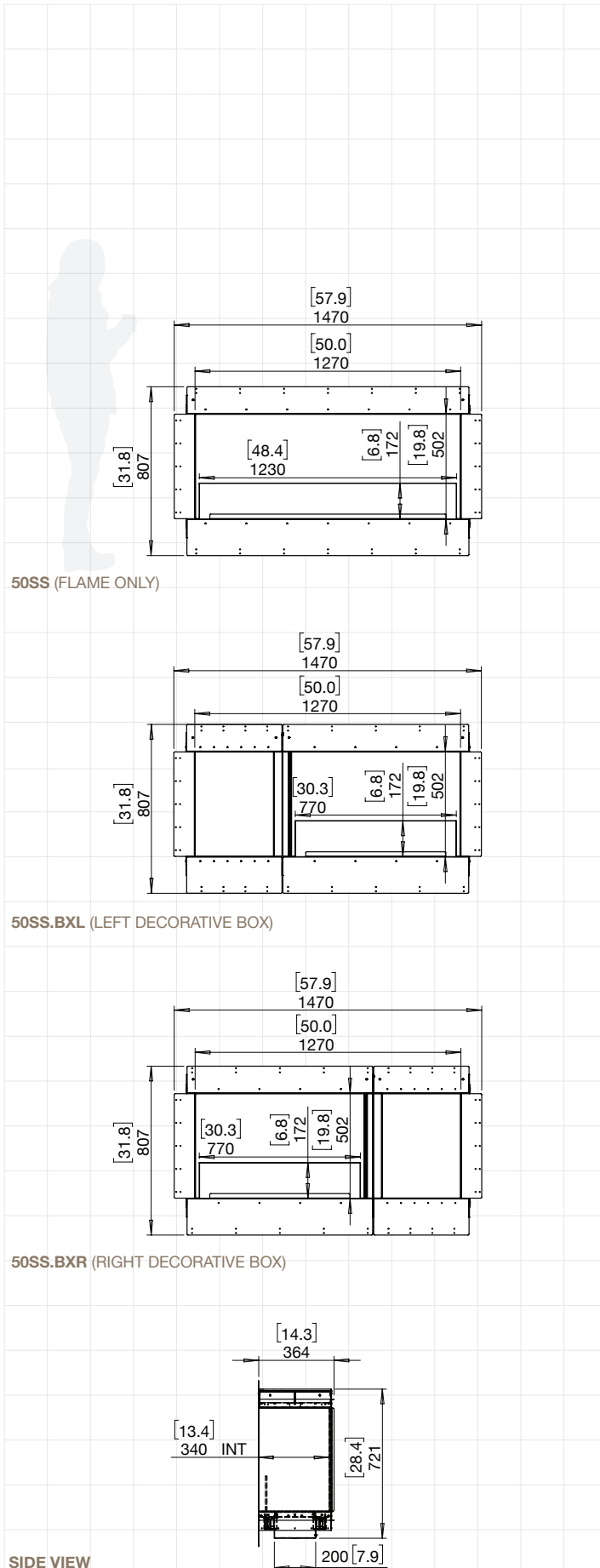

50SS (FLAME ONLY)

50SS.BXL (LEFT DECORATIVE BOX)

50SS.BXR (RIGHT DECORATIVE BOX)

SIDE VIEW

FOR MORE INFORMATION PLEASE REFERENCE THE CLEARANCE & INSTALLATION MANUAL

Disclaimer: All product specifications and data are subject to change without notice and believed to be correct at the time of publication. The Fire Company Pty Ltd (TFC), its affiliates, agents, and employees, and all persons acting on its or their behalf (collectively, "The Fire Company"), disclaim any and all liability for any errors, inaccuracies or incompleteness contained herein or in any other disclosure relating to any product. TFC disclaims any and all liability arising out of the use or application of any product described herein or of any information provided herein to the maximum extent permitted by law. The product specifications do not expand or otherwise modify TFC's terms and conditions of purchase, including but not limited to the warranty expressed therein, which apply to these products. No license, express or implied, by estoppel or otherwise, to any intellectual property rights is granted by this document or by any conduct of TFC. Customers using or selling TFC products not expressly indicated for use in such applications do so entirely at their own risk and agree to fully indemnify TFC for any damages arising or resulting from such use or sale. Please contact authorised personnel from TFC to obtain written terms and conditions regarding products designed for such applications. Images are indicative only.

SINGLE SIDED FIREPLACES

| | |
|--------------------|---|
| Application | Indoor & Outdoor |
| Materials | Mild Steel (Zinc Sealed), Toughened Glass, Stainless Steel & Glass Charcoal as Decorative Media |
| Colours | Black Firebox, Stainless Steel Burner/s |
| Fuel Type | e-NRG Bioethanol |

FLEX60.BX

ESF.1.FX.60SS.BXL

ESF.1.FX.60SS.BXR (Not available in USA & Canada)

| | |
|---|---|
| Weight | 83.9kg [184.6lbs] (Incl. burner/s, glass charcoal, glass) |
| Burner* | XL700 x 1 |
| Volume Capacity | 7 Litres [1.8 Gallons] |
| Heats on Average (when used indoors) | Over 50 square metres [538 square feet] |
| Burn Time | 9 - 12 hours (approx) |
| Minimum Room Size | 90 cubic metres [3178 cubic feet] per fireplace. |

Physical model dimensions should be verified against cut out dimensions BEFORE installation begins to confirm tolerances align.

* The efficiency data outlined above is indicative only and may vary depending on the model purchased, weather conditions, installation and bioethanol used.

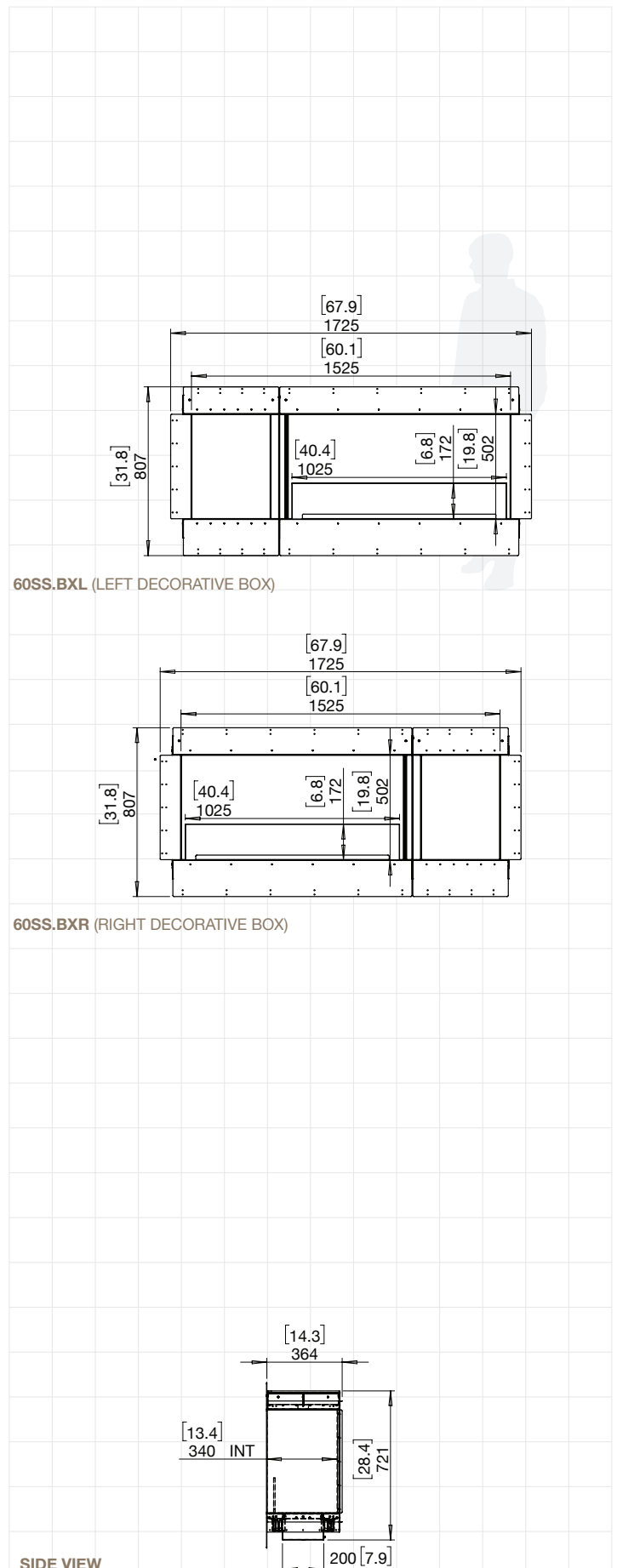

FOR MORE INFORMATION PLEASE REFERENCE THE CLEARANCE & INSTALLATION MANUAL

Disclaimer: All product specifications and data are subject to change without notice and believed to be correct at the time of publication. The Fire Company Pty Ltd (TFC), its affiliates, agents, and employees, and all persons acting on its or their behalf (collectively, "The Fire Company"), disclaim any and all liability for any errors, inaccuracies or incompleteness contained herein or in any other disclosure relating to any product. TFC disclaims any and all liability arising out of the use or application of any product described herein or of any information provided herein to the maximum extent permitted by law. The product specifications do not expand or otherwise modify TFC's terms and conditions of purchase, including but not limited to the warranty expressed therein, which apply to these products. No license, express or implied, by estoppel or otherwise, to any intellectual property rights is granted by this document or by any conduct of TFC. Customers using or selling TFC products not expressly indicated for use in such applications do so entirely at their own risk and agree to fully indemnify TFC for any damages arising or resulting from such use or sale. Please contact authorised personnel from TFC to obtain written terms and conditions regarding products designed for such applications. Images are indicative only.

SINGLE SIDED FIREPLACES

| | |
|--------------------|---|
| Application | Indoor & Outdoor |
| Materials | Mild Steel (Zinc Sealed), Toughened Glass, Stainless Steel & Glass Charcoal as Decorative Media |
| Colours | Black Firebox, Stainless Steel Burner/s |
| Fuel Type | e-NRG Bioethanol |

FLEX68

ESF.2.FX.68SS

| | |
|--------------------------|---|
| Weight | 97.1kg [213.6lbs] (incl. burner/s, glass charcoal, glass) |
| Burner* | XL1200 x 1 |
| Volume Capacity | 10 Litres [2.6 Gallons] x 1 |
| Heats on Average | Over 65 square metres [700 square feet] |
| Burn Time | 9 - 14 hours (approx) |
| Minimum Room Size | 115 cubic metres [4061 cubic feet] per fireplace |

ESF.1.FX.68SS.BX2

| | |
|--------------------------|---|
| Weight | 93.9kg [206.7lbs] (incl. burner/s, glass charcoal, glass) |
| Burner* | XL500 x 1 |
| Volume Capacity | 5 Litres [1.3 Gallons] |
| Heats on Average | Over 40 square metres [430.6 square feet] |
| Burn Time | 10 - 13 hours (approx) |
| Minimum Room Size | 80 cubic metres [2825 cubic feet] per fireplace. |

ESF.1.FX.68SS.BXL

ESF.1.FX.68SS.BXR

| | |
|--------------------------|---|
| Weight | 95.1kg [209.2lbs] (incl. burner/s, glass charcoal, glass) |
| Burner* | XL900 x 1 |
| Volume Capacity | 9 Litres [2.4 Gallons] |
| Heats on Average | Over 60 square metres [645 square feet] |
| Burn Time | 8 - 13 hours (approx) |
| Minimum Room Size | 110 cubic metres [3884 cubic feet] per fireplace. |

Physical model dimensions should be verified against cut out dimensions BEFORE installation begins to confirm tolerances align.

* The efficiency data outlined above is indicative only and may vary depending on the model purchased, weather conditions, installation and bioethanol used.

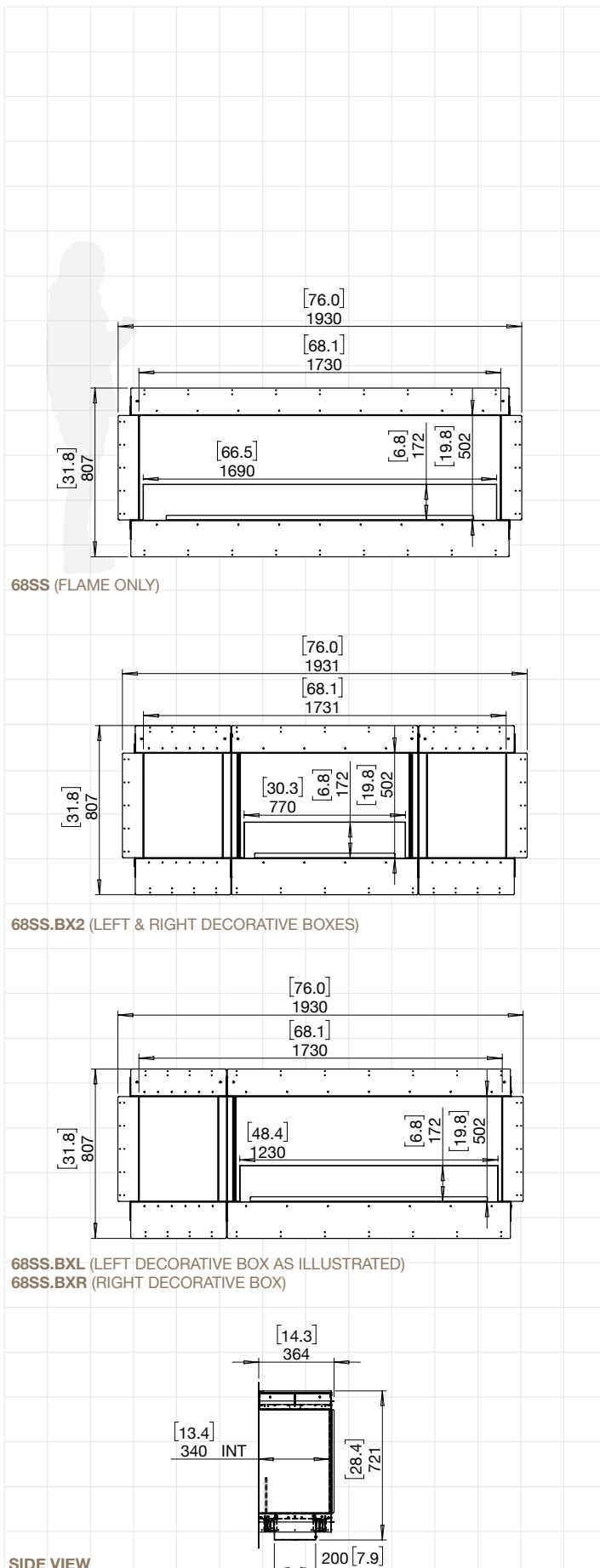

68SS (FLAME ONLY)

68SS.BX2 (LEFT & RIGHT DECORATIVE BOXES)

68SS.BXL (LEFT DECORATIVE BOX AS ILLUSTRATED)
68SS.BXR (RIGHT DECORATIVE BOX)

SIDE VIEW

FOR MORE INFORMATION PLEASE REFERENCE THE CLEARANCE & INSTALLATION MANUAL

Disclaimer: All product specifications and data are subject to change without notice and believed to be correct at the time of publication. The Fire Company Pty Ltd (TFC), its affiliates, agents, and employees, and all persons acting on its or their behalf (collectively, "The Fire Company"), disclaim any and all liability for any errors, inaccuracies or incompleteness contained herein or in any other disclosure relating to any product. TFC disclaims any and all liability arising out of the use or application of any product described herein to the maximum extent permitted by law. The product specifications do not expand or otherwise modify TFC's terms and conditions of purchase, including but not limited to the warranty expressed therein, which apply to these products. No license, express or implied, by estoppel or otherwise, to any intellectual property rights is granted by this document or by any conduct of TFC. Customers using or selling TFC products not expressly indicated for use in such applications do so entirely at their own risk and agree to fully indemnify TFC for any damages arising or resulting from such use or sale. Please contact authorised personnel from TFC to obtain written terms and conditions regarding products designed for such applications. Images are indicative only.

SINGLE SIDED FIREPLACES

| | |
|--------------------|---|
| Application | Indoor & Outdoor |
| Materials | Mild Steel (Zinc Sealed), Toughened Glass, Stainless Steel & Glass Charcoal as Decorative Media |
| Colours | Black Firebox, Stainless Steel Burner/s |
| Fuel Type | e-NRG Bioethanol |

FLEX78.BX2

ESF.1.FX.78SS.BX2 (Not available in USA & Canada)

| | |
|--|--|
| Weight | 107.8kg [237.1lbs] (incl. burner/s, glass charcoal, glass) |
| Burner* | XL700 x 1 |
| Volume Capacity | 7 Litres [1.8 Gallons] |
| Heats on Average (when used indoors) | Over 50 square metres [538 square feet] |
| Burn Time | 9 - 12 hours (approx) |
| Minimum Room Size | 90 cubic metres [3178 cubic feet] per fireplace. |

Physical model dimensions should be verified against cut out dimensions BEFORE installation begins to confirm tolerances align.

* The efficiency data outlined above is indicative only and may vary depending on the model purchased, weather conditions, installation and bioethanol used.

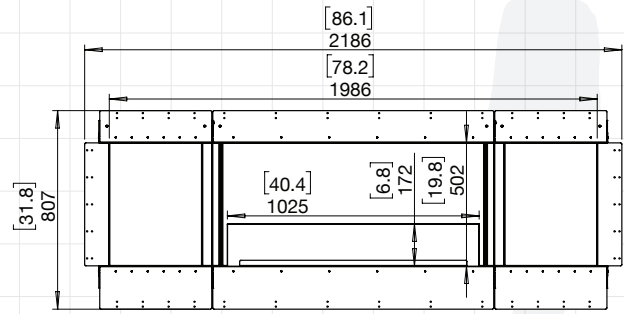

78SS.BX2 (LEFT & RIGHT DECORATIVE BOXES)

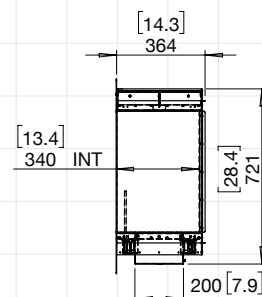

SIDE VIEW

FOR MORE INFORMATION PLEASE REFERENCE THE CLEARANCE & INSTALLATION MANUAL

Disclaimer. All product specifications and data are subject to change without notice and believed to be correct at the time of publication. The Fire Company Pty Ltd (TFC), its affiliates, agents, and employees, and all persons acting on its or their behalf (collectively, "The Fire Company"), disclaim any and all liability for any errors, inaccuracies or incompleteness contained herein or in any other disclosure relating to any product. TFC disclaims any and all liability arising out of the use or application of any product described herein or of any information provided herein to the maximum extent permitted by law. The product specifications do not expand or otherwise modify TFC's P/Ls terms and conditions of purchase, including but not limited to the warranty expressed therein, which apply to these products. No license, express or implied, by estoppel or otherwise, to any intellectual property rights is granted by this document or by any conduct of TFC. Customers using or selling TFC products not expressly indicated for use in such applications do so entirely at their own risk and agree to fully indemnify TFC for any damages arising or resulting from such use or sale. Please contact authorised personnel from TFC to obtain written terms and conditions regarding products designed for such applications. Images are indicative only.

SINGLE SIDED FIREPLACES

| | |
|--------------------|---|
| Application | Indoor & Outdoor |
| Materials | Mild Steel (Zinc Sealed), Toughened Glass, Stainless Steel & Glass Charcoal as Decorative Media |
| Colours | Black Firebox, Stainless Steel Burner/s |
| Fuel Type | e-NRG Bioethanol |

FLEX86

ESF.1.FX.86SS

| | |
|--------------------------|--|
| Weight | 121.5kg [267.3lbs] (Incl. burner/s, glass charcoal, glass) |
| Burner* | XL900 x 2 |
| Volume Capacity | 9 Litres [2.4 Gallons] x 2 |
| Heats on Average | Over 120 square metres [1290 square feet] |
| Burn Time | 8 - 13 hours (approx) |
| Minimum Room Size | 220 cubic metres [7768 cubic feet] per fireplace |

ESF.1.FX.86SS.BX2

| | |
|--------------------------|--|
| Weight | 118.8kg [261.4lbs] (Incl. burner/s, glass charcoal, glass) |
| Burner* | XL900 x 1 |
| Volume Capacity | 9 Litres [2.4 Gallons] |
| Heats on Average | Over 60 square metres [645 square feet] |
| Burn Time | 8 - 13 hours (approx) |
| Minimum Room Size | 110 cubic metres [3884 cubic feet] per fireplace |

ESF.2.FX.86SS.BXL

ESF.2.FX.86SS.BXR

| | |
|--------------------------|--|
| Weight | 119.4kg [262.7lbs] (Incl. burner/s, glass charcoal, glass) |
| Burner* | XL1200 x 1 |
| Volume Capacity | 10 Litres [2.6 Gallons] x 1 |
| Heats on Average | Over 65 square metres [700 square feet] |
| Burn Time | 9 - 14 hours (approx) |
| Minimum Room Size | 115 cubic metres [4061 cubic feet] per fireplace |

Physical model dimensions should be verified against cut out dimensions BEFORE installation begins to confirm tolerances align.

* The efficiency data outlined above is indicative only and may vary depending on the model purchased, weather conditions, installation and bioethanol used.

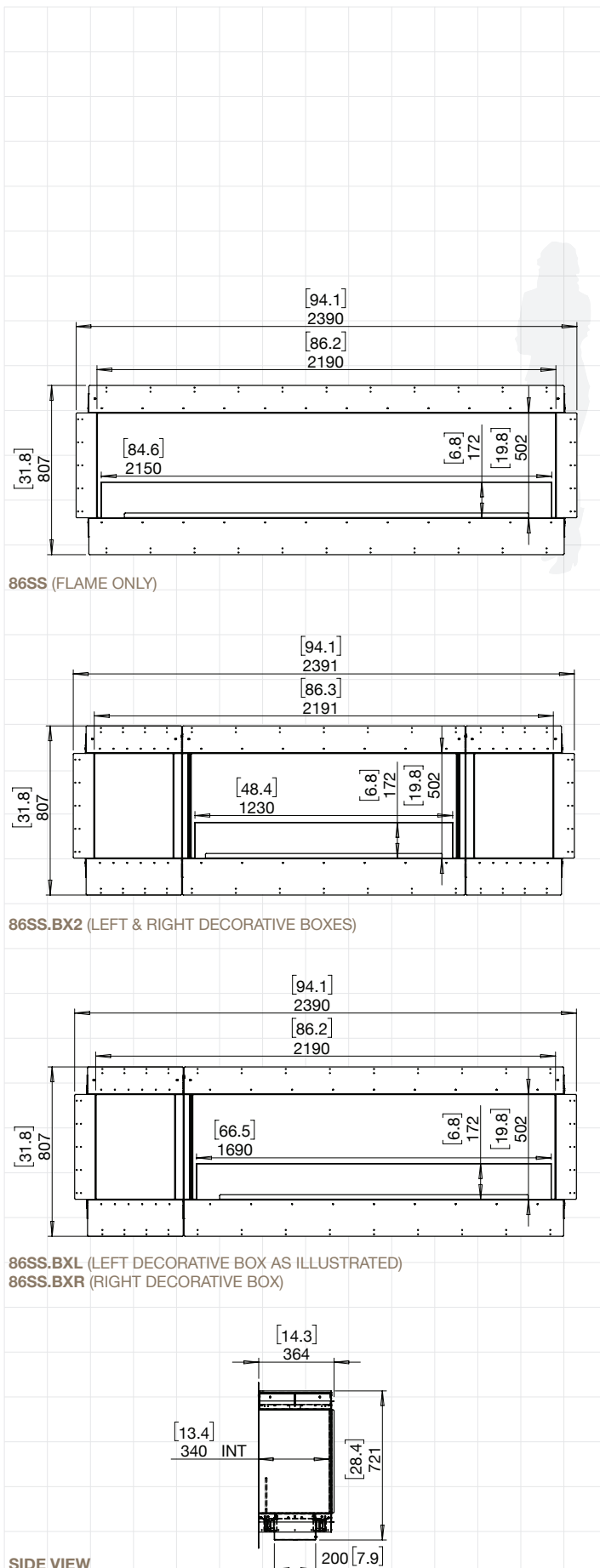

86SS (FLAME ONLY)

86SS.BX2 (LEFT & RIGHT DECORATIVE BOXES)

86SS.BXL (LEFT DECORATIVE BOX AS ILLUSTRATED)
86SS.BXR (RIGHT DECORATIVE BOX)

SIDE VIEW

FOR MORE INFORMATION PLEASE REFERENCE THE CLEARANCE & INSTALLATION MANUAL

Disclaimer: All product specifications and data are subject to change without notice and believed to be correct at the time of publication. The Fire Company Pty Ltd (TFC), its affiliates, agents, and employees, and all persons acting on its or their behalf (collectively, "The Fire Company"), disclaim any and all liability for any errors, inaccuracies or incompleteness contained herein or in any other disclosure relating to any product. TFC disclaims any and all liability arising out of the use or application of any product described herein to the maximum extent permitted by law. The product specifications do not expand or otherwise modify TFC's terms and conditions of purchase, including but not limited to the warranty expressed therein, which apply to these products. No license, express or implied, by estoppel or otherwise, to any intellectual property rights is granted by this document or by any conduct of TFC. Customers using or selling TFC products not expressly indicated for use in such applications do so entirely at their own risk and agree to fully indemnify TFC for any damages arising or resulting from such use or sale. Please contact authorised personnel from TFC to obtain written terms and conditions regarding products designed for such applications. Images are indicative only.

SINGLE SIDED FIREPLACES

| | |
|--------------------|---|
| Application | Indoor & Outdoor |
| Materials | Mild Steel (Zinc Sealed), Toughened Glass, Stainless Steel & Glass Charcoal as Decorative Media |
| Colours | Black Firebox, Stainless Steel Burner/s |
| Fuel Type | e-NRG Bioethanol |

FLEX104

ESF.1.FX.104SS

| | |
|--------------------------|--|
| Weight | 146.2kg [321.6lbs] (Incl. burner/s, glass charcoal, glass) |
| Burner* | XL1200 x 2 |
| Volume Capacity | 10 Litres [2.6 Gallons] x 2 |
| Heats on Average | Over 130 square metres [1400 square feet] |
| Burn Time | 9 - 14 hours (approx) |
| Minimum Room Size | 230 cubic metres [8122 cubic feet] per fireplace |

ESF.2.FX.104SS.BX2

| | |
|--------------------------|--|
| Weight | 193.8kg [426.4lbs] (Incl. burner/s, glass charcoal, glass) |
| Burner* | XL1200 x 1 |
| Volume Capacity | 10 Litres [2.6 Gallons] x 1 |
| Heats on Average | Over 65 square metres [700 square feet] |
| Burn Time | 9 - 14 hours (approx) |
| Minimum Room Size | 115 cubic metres [4061 cubic feet] per fireplace |

ESF.1.FX.104SS.BXL ESF.1.FX.104SS.BXR

| | |
|--------------------------|--|
| Weight | 145.2kg [319.4lbs] (Incl. burner/s, glass charcoal, glass) |
| Burner* | XL900 x 2 |
| Volume Capacity | 9 Litres [2.4 Gallons] x 2 |
| Heats on Average | Over 120 square metres [1290 square feet] |
| Burn Time | 8 - 13 hours (approx) |
| Minimum Room Size | 220 cubic metres [7768 cubic feet] per fireplace |

Physical model dimensions should be verified against cut out dimensions BEFORE installation begins to confirm tolerances align.

* The efficiency data outlined above is indicative only and may vary depending on the model purchased, weather conditions, installation and bioethanol used.

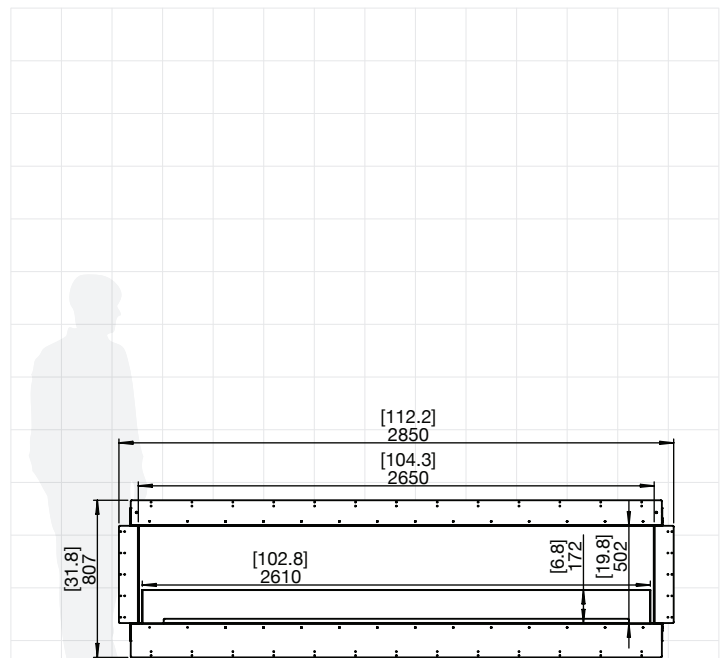

104SS (FLAME ONLY)

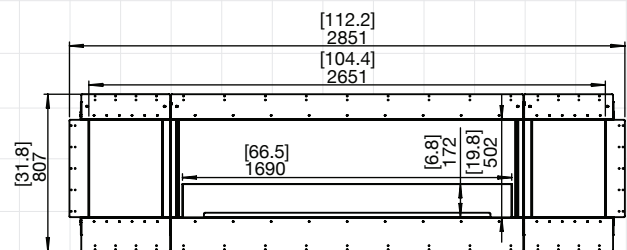

104SS.BX2 (LEFT & RIGHT DECORATIVE BOXES)

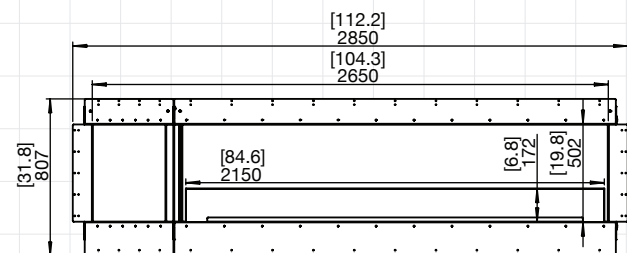

104SS.BXL (LEFT DECORATIVE BOX AS ILLUSTRATED)
104SS.BXR (RIGHT DECORATIVE BOX)

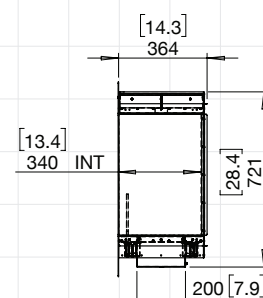

SIDE VIEW

FOR MORE INFORMATION PLEASE REFERENCE THE CLEARANCE & INSTALLATION MANUAL

Disclaimer: All product specifications and data are subject to change without notice and believed to be correct at the time of publication. The Fire Company Pty Ltd (TFC), its affiliates, agents, and employees, and all persons acting on its or their behalf (collectively, "The Fire Company"), disclaim any and all liability for any errors, inaccuracies or incompleteness contained herein or in any other disclosure relating to any product. TFC disclaims any and all liability arising out of the use or application of any product described herein or of any information provided herein to the maximum extent permitted by law. The product specifications do not expand or otherwise modify TFC's terms and conditions of purchase, including but not limited to the warranty expressed therein, which apply to these products. No license, express or implied, by estoppel or otherwise, to any intellectual property rights is granted by this document or by any conduct of TFC. Customers using or selling TFC products not expressly indicated for use in such applications do so entirely at their own risk and agree to fully indemnify TFC for any damages arising or resulting from such use or sale. Please contact authorised personnel from TFC to obtain written terms and conditions regarding products designed for such applications. Images are indicative only.

SINGLE SIDED FIREPLACES

| | |
|--------------------|---|
| Application | Indoor & Outdoor |
| Materials | Mild Steel (Zinc Sealed), Toughened Glass, Stainless Steel & Glass Charcoal as Decorative Media |
| Colours | Black Firebox, Stainless Steel Burner/s |
| Fuel Type | e-NRG Bioethanol |

FLEX122

ESF.1.FX.122SS

| | |
|--------------------------|--|
| Weight | 171.5kg [377.3lbs] (incl. burner/s, glass charcoal, glass) |
| Burner* | XL900 x 3 |
| Volume Capacity | 9 Litres [2.4 Gallons] x 3 |
| Heats on Average | Over 180 square metres [1935 square feet] |
| Burn Time | 8 - 13 hours (approx) |
| Minimum Room Size | 330 cubic metres [11652 cubic feet] per fireplace |

ESF.1.FX.122SS.BX2

| | |
|--------------------------|--|
| Weight | 168.9kg [371.6lbs] (incl. burner/s, glass charcoal, glass) |
| Burner* | XL900 x 2 |
| Volume Capacity | 9 Litres [2.4 Gallons] x 2 |
| Heats on Average | Over 120 square metres [1290 square feet] |
| Burn Time | 8 - 13 hours (approx) |
| Minimum Room Size | 220 cubic metres [7768 cubic feet] per fireplace |

ESF.1.FX.122SS.BXL ESF.1.FX.122SS.BXR

| | |
|--------------------------|--|
| Weight | 170.1kg [374.2lbs] (incl. burner/s, glass charcoal, glass) |
| Burner* | XL1200 x 2 |
| Volume Capacity | 10 Litres [2.6 Gallons] x 2 |
| Heats on Average | Over 130 square metres [1400 square feet] |
| Burn Time | 9 - 14 hours (approx) |
| Minimum Room Size | 230 cubic metres [8122 cubic feet] per fireplace |

Physical model dimensions should be verified against cut out dimensions BEFORE installation begins to confirm tolerances align.

* The efficiency data outlined above is indicative only and may vary depending on the model purchased, weather conditions, installation and bioethanol used.

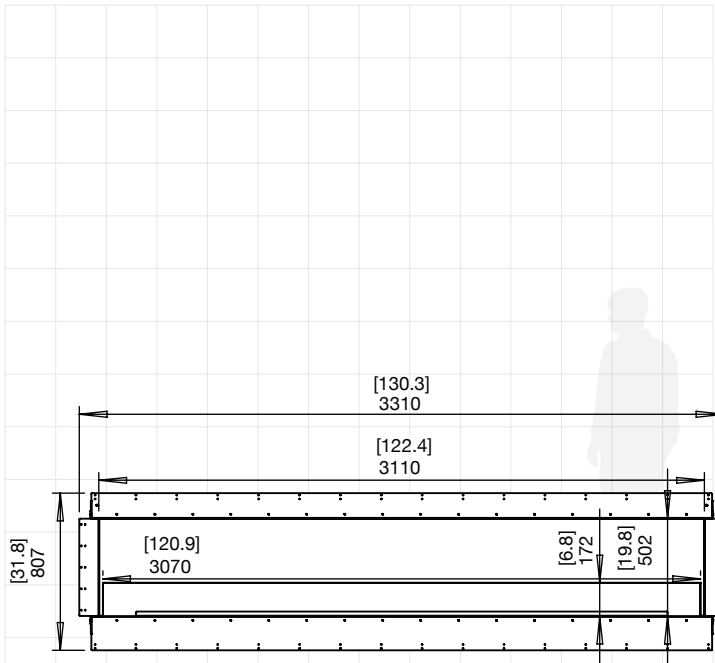

122SS (FLAME ONLY)

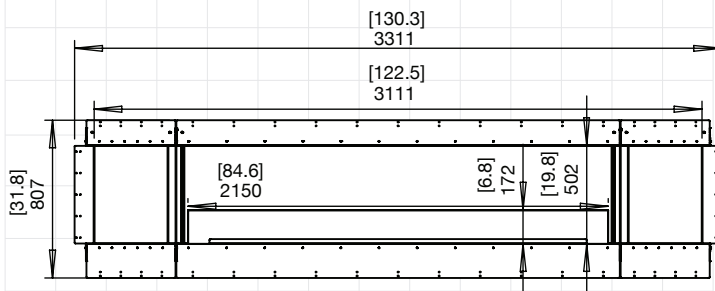

122SS.BX2 (LEFT & RIGHT DECORATIVE BOXES)

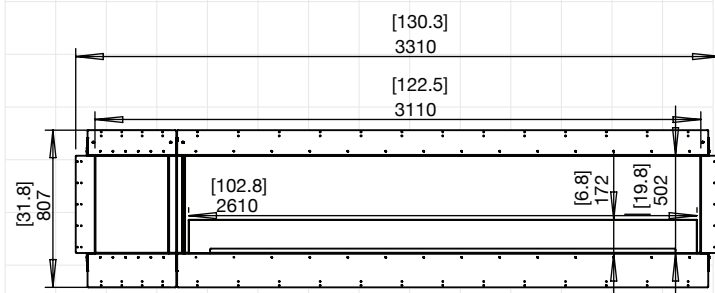

122SS.BXL (LEFT DECORATIVE BOX AS ILLUSTRATED)
122SS.BXR (RIGHT DECORATIVE BOX)

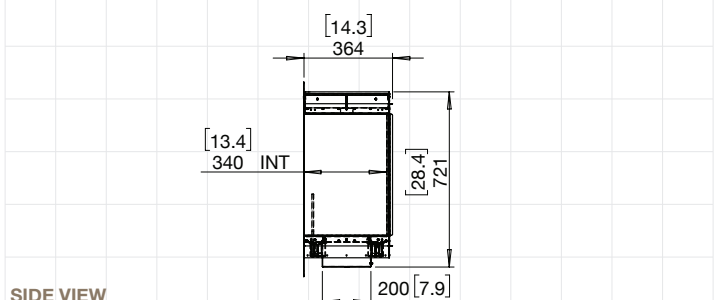

SIDE VIEW

FOR MORE INFORMATION PLEASE REFERENCE THE CLEARANCE & INSTALLATION MANUAL

Disclaimer: All product specifications and data are subject to change without notice and believed to be correct at the time of publication. The Fire Company Pty Ltd (TFC), its affiliates, agents, and employees, and all persons acting on its or their behalf (collectively, "The Fire Company"), disclaim any and all liability for any errors, inaccuracies or incompleteness contained herein or in any other disclosure relating to any product. TFC disclaims any and all liability arising out of the use or application of any product described herein to the maximum extent permitted by law. The product specifications do not expand or otherwise modify TFC's terms and conditions of purchase, including but not limited to the warranty expressed therein, which apply to these products. No license, express or implied, by estoppel or otherwise, to any intellectual property rights is granted by this document or by any conduct of TFC. Customers using or selling TFC products not expressly indicated for use in such applications do so entirely at their own risk and agree to fully indemnify TFC for any damages arising or resulting from such use or sale. Please contact authorised personnel from TFC to obtain written terms and conditions regarding products designed for such applications. Images are indicative only.

SINGLE SIDED FIREPLACES

| | |
|--------------------|---|
| Application | Indoor & Outdoor |
| Materials | Mild Steel (Zinc Sealed), Toughened Glass, Stainless Steel & Glass Charcoal as Decorative Media |
| Colours | Black Firebox, Stainless Steel Burner/s |
| Fuel Type | e-NRG Bioethanol |

FLEX140

ESF.1.FX.140SS.BX2

| | |
|--------------------------|--|
| Weight | 193.8kg [426.4lbs] (Incl. burner/s, glass charcoal, glass) |
| Burner* | XL1200 x 2 |
| Volume Capacity | 10 Litres [2.6 Gallons] x 2 |
| Heats on Average | Over 130 square metres [1400 square feet] |
| Burn Time | 9 - 14 hours (approx) |
| Minimum Room Size | 230 cubic metres [8122 cubic feet] per fireplace |

ESF.1.FX.140SS.BXL ESF.1.FX.140SS.BXR

| | |
|--------------------------|--|
| Weight | 195.2kg [429.4lbs] (Incl. burner/s, glass charcoal, glass) |
| Burner* | XL900 x 3 |
| Volume Capacity | 9 Litres [2.4 Gallons] x 3 |
| Heats on Average | Over 180 square metres [1935 square feet] |
| Burn Time | 8 - 13 hours (approx) |
| Minimum Room Size | 330 cubic metres [11652 cubic feet] per fireplace |

Physical model dimensions should be verified against cut out dimensions BEFORE installation begins to confirm tolerances align.

* The efficiency data outlined above is indicative only and may vary depending on the model purchased, weather conditions, installation and bioethanol used.

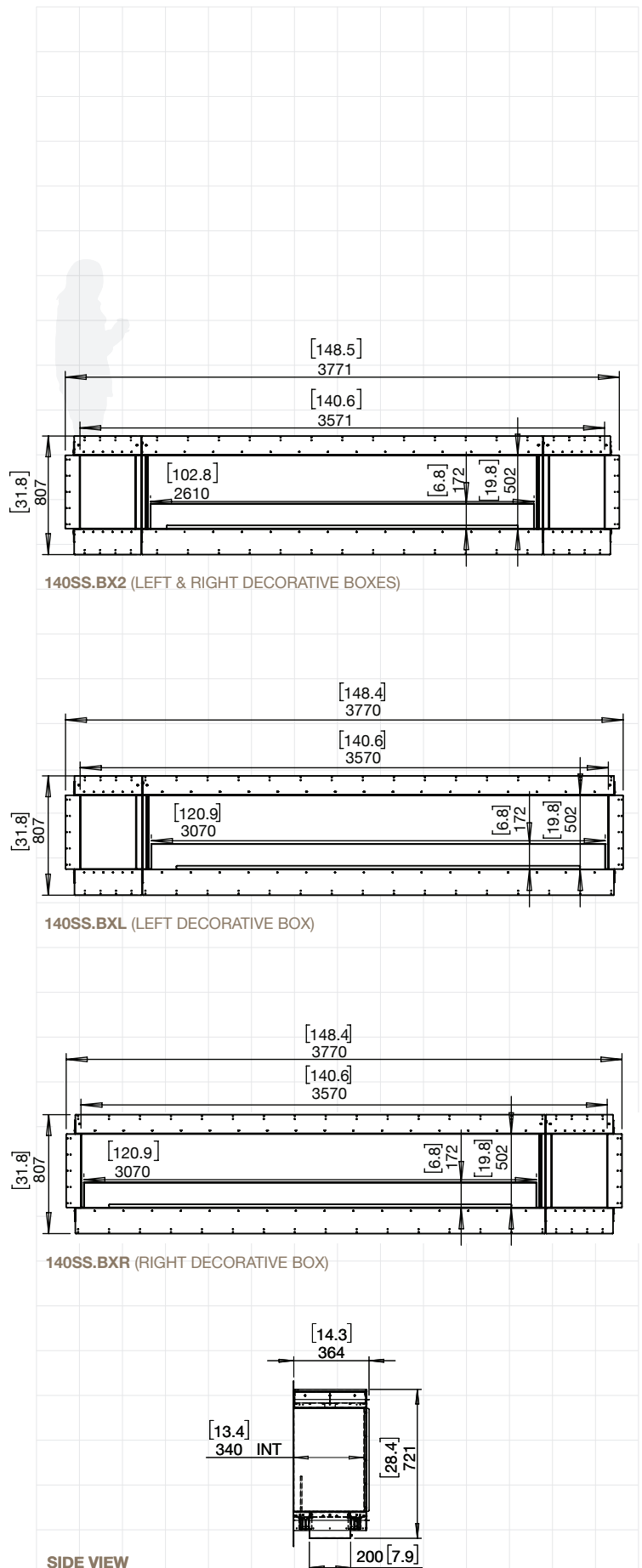

FOR MORE INFORMATION PLEASE REFERENCE THE CLEARANCE & INSTALLATION MANUAL

Disclaimer: All product specifications and data are subject to change without notice and believed to be correct at the time of publication. The Fire Company Pty Ltd (TFC), its affiliates, agents, and employees, and all persons acting on its or their behalf (collectively, "The Fire Company"), disclaim any and all liability for any errors, inaccuracies or incompleteness contained herein or in any other disclosure relating to any product. TFC disclaims any and all liability arising out of the use or application of any product described herein or of any information provided herein to the maximum extent permitted by law. The product specifications do not expand or otherwise modify TFC's terms and conditions of purchase, including but not limited to the warranty expressed therein, which apply to these products. No license, express or implied, by estoppel or otherwise, to any intellectual property rights is granted by this document or by any conduct of TFC. Customers using or selling TFC products not expressly indicated for use in such applications do so entirely at their own risk and agree to fully indemnify TFC for any damages arising or resulting from such use or sale. Please contact authorised personnel from TFC to obtain written terms and conditions regarding products designed for such applications. Images are indicative only.

SINGLE SIDED FIREPLACES

| | |
|--------------------|---|
| Application | Indoor & Outdoor |
| Materials | Mild Steel (Zinc Sealed), Toughened Glass, Stainless Steel & Glass Charcoal as Decorative Media |
| Colours | Black Firebox, Stainless Steel Burner/s |
| Fuel Type | e-NRG Bioethanol |

FLEX158

ESF.1.FX.158SS

| | |
|--------------------------|--|
| Weight | 222.1kg [488.6lbs] (Incl. burner/s, glass charcoal, glass) |
| Burner* | XL1200 x 3 |
| Volume Capacity | 10 Litres [2.6 Gallons] x 3 |
| Heats on Average | Over 195 square metres [2100 square feet] |
| Burn Time | 9 - 14 hours (approx) |
| Minimum Room Size | 345 cubic metres [12183 cubic feet] per fireplace |

ESF.1.FX.158SS.BX2

| | |
|--------------------------|--|
| Weight | 218.9kg [481.6lbs] (Incl. burner/s, glass charcoal, glass) |
| Burner* | XL900 x 3 |
| Volume Capacity | 9 Litres [2.4 Gallons] x 3 |
| Heats on Average | Over 180 square metres [1935 square feet] |
| Burn Time | 8 - 13 hours (approx) |
| Minimum Room Size | 330 cubic metres [11652 cubic feet] per fireplace |

Physical model dimensions should be verified against cut out dimensions BEFORE installation begins to confirm tolerances align.

* The efficiency data outlined above is indicative only and may vary depending on the model purchased, weather conditions, installation and bioethanol used.

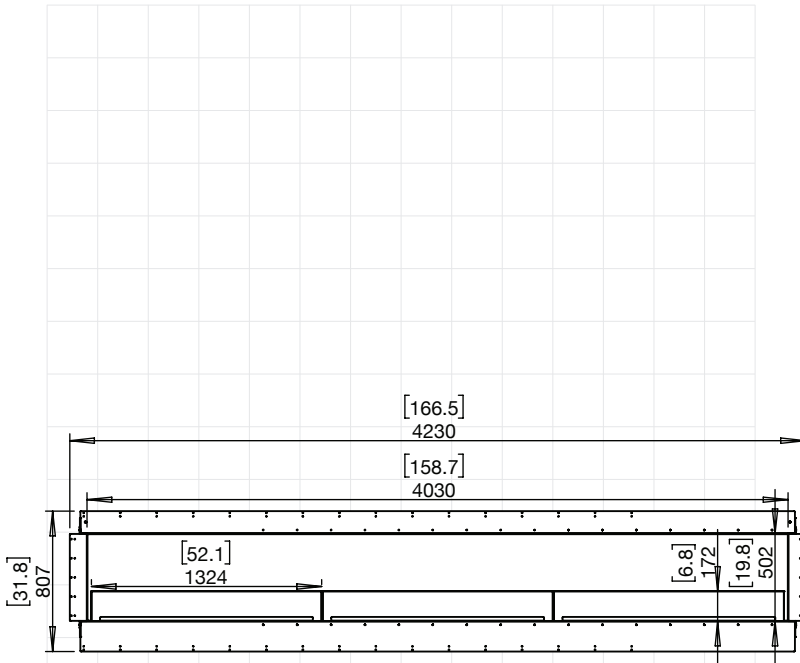

158SS (FLAME ONLY)

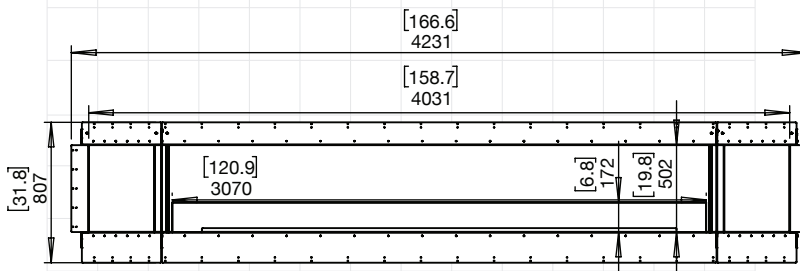

158SS.BX2 (LEFT & RIGHT DECORATIVE BOXES)

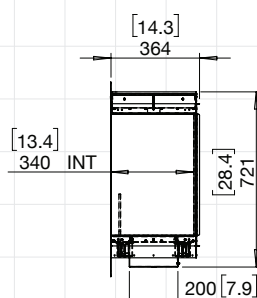

SIDE VIEW

FOR MORE INFORMATION PLEASE REFERENCE THE CLEARANCE & INSTALLATION MANUAL

Disclaimer: All product specifications and data are subject to change without notice and believed to be correct at the time of publication. The Fire Company Pty Ltd (TFC), its affiliates, agents, and employees, and all persons acting on its or their behalf (collectively, "The Fire Company"), disclaim any and all liability for any errors, inaccuracies or incompleteness contained herein or in any other disclosure relating to any product. TFC disclaims any and all liability arising out of the use or application of any product described herein to the maximum extent permitted by law. The product specifications do not expand or otherwise modify TFC's terms and conditions of purchase, including but not limited to the warranty expressed therein, which apply to these products. No license, express or implied, by estoppel or otherwise, to any intellectual property rights is granted by this document or by any conduct of TFC. Customers using or selling TFC products not expressly indicated for use in such applications do so entirely at their own risk and agree to fully indemnify TFC for any damages arising or resulting from such use or sale. Please contact authorised personnel from TFC to obtain written terms and conditions regarding products designed for such applications. Images are indicative only.